

CHIUSINO RETTANGOLARE apertura esterna

- RECTANGULAR manhole cover outwards opening
- Trappe RECTANGULAIRE avec ouverture à l'extérieur
- Tapa RECTANGULAR de apertura externa
- RECHTECKIGE Klapptür, Aussenöffnung
- ПРЯМОУГОЛЬНАЯ крышка люка с внешним открытием

654L ART
 280 X 400 mm
 Rev 0

COPERCHIO COVER	C
TELAIO FRAME	T
BRACCIO ARM	B
VOLANTINO HANDWHEEL	V
GUARNIZIONE GASKET	G

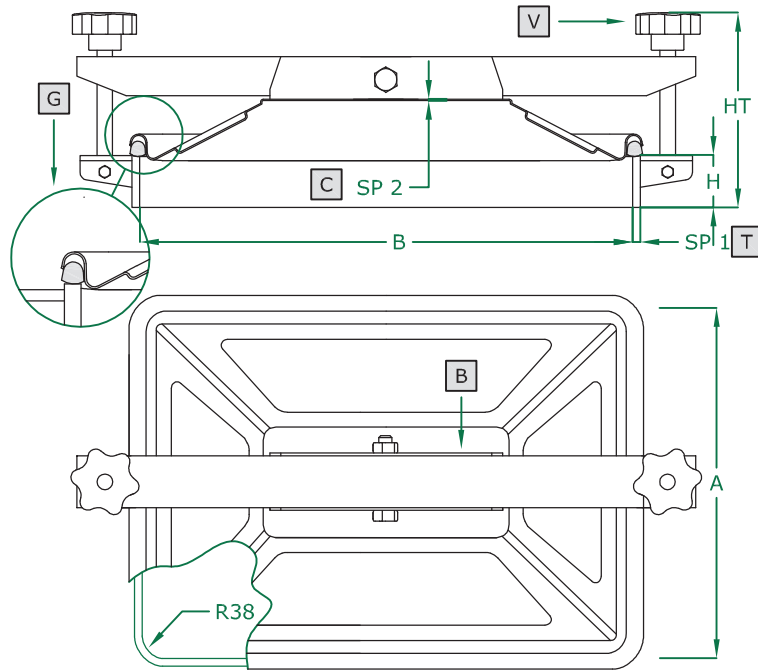

	STANDARD		OPTIONAL			
H X SP1	50 X 6		100 X 6			
TELAIO	SAT		MPL			
GUARNIZIONE	PARA	EPDM	NEOPRENE	NBR	SILICONE	VITON
VOLANTINO	125 001 V NYLON	125 021 V NYLON	125 022 CHROME P.	125 023 S. STEEL	125 024 ALUMINIUM	125 031 S. STEEL

ART	A	B	SP2	HT (standard)	BAR max: (standard)	COVER type:	GASKET code:	KG (standard)
654L	280	400	1,2	155	0,1	CN	120 617	7,5